

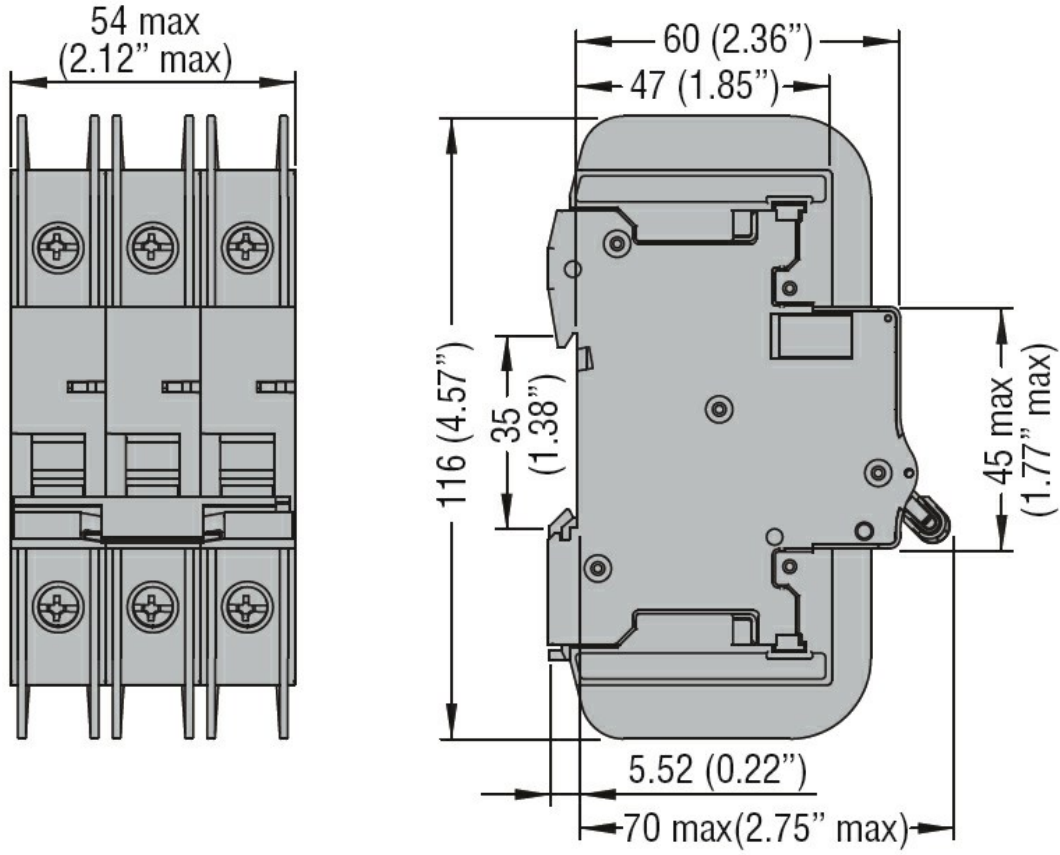

Product designation	Miniature circuit breaker (MCB)		
Product type designation	P1 MB		
Number of poles	3P		
Number of DIN modules	3		
Compliance	IEC / UL489		
Electrical features			
Rated insulation voltage U_i IEC/EN	V	440	
Rated impulse withstand voltage U_{imp}	kV	4	
Rated operational voltage AC (IEC)	VAC	230/400	
Rated operational voltage AC (UL)	V	240	
Rated frequency	Hz	50/60	
Rated current (I_n)	A	35	
Tripping curve	D		
Short circuit rating (IEC)	kA	10	
Short circuit rating (UL)	kA	10	
Electrical life	cycles	10000	
Power dissipation per pole max	W	2.46	
Ambient conditions			
Operating temperature	min	°C	-40
	max	°C	+70
Storage temperature	min	°C	-40
	max	°C	+80
Max altitude	m	2000	
Mechanical features			
Operating position	normal		Vertical plan
			35mm DIN rail
Fixing			
Tightening torque for terminals	min	Nm	1.8
	max	Nm	2
	min	lbin	16
	max	lbin	17.7
Terminals tool	Pz 2		
Conductor section	IEC		
	min	mm ²	1
	max	mm ²	35
	AWG/Kcmil		
	min		14
	max		6
Mechanical life	cycles	20000	
Weight	g	388	

Frontal IP degree	IP20
Pollution degree	2

Dimensions [mm (in)]



Wiring diagrams

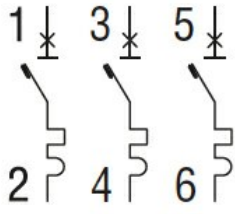

Certifications and compliance

Compliance	IEC/EN 60947-2
	UL489
Certifications	cULus
	EAC

ETIM classification

ETIM 8.0	EC000042 - Miniature circuit breaker (MCB)
----------	--